

PRUVEEO



USER MANUAL

Safety information

To prevent injury to yourself or others, or damage to your device, read all safety information before using.



Warning

Failure to comply with safety warnings and regulations can result in serious injury or death.

Pruveeo Dash Cam is not intended to be touched, modified, or calibrated while operating a vehicle. Pruveeo is not responsible for any damages resulting from the user's misuse of the camera.

Do not use damaged power cords or plugs, or loose electrical sockets. Faulty connections can cause electric shock or fire.

Do not touch the car charger with wet hands or disconnect the charger by pulling the cord. Doing so may result in electrocution.

Do not use a bent or damaged car charger. Doing so may cause electric shock or fire.

Do not use your device while it is charging or touch your device with wet hands. Doing so may cause electric shock.

Do not short-circuit the charger or the device. Doing so may cause electric shock or fire, or cause the battery to malfunction or explode.

Use only manufacturer-approved chargers, accessories, and supplies.

- Using generic chargers may shorten the life of your device or cause the device to malfunction. They may also cause fire or cause the battery to explode.
- Use only the manufacturer-approved charger specifically designed for your device. Using an incompatible charger can cause serious personal injury or damage to your device.
- Pruveeo cannot be responsible for the user's safety when using accessories or supplies that are not approved by Pruveeo.

Do not drop the charger or device, or subject them to impact. Handle and dispose of the charger and device with care.

- Never crush or puncture the device.
- Never dispose of the device in a fire.
- Never place the device in or on heating devices, such as microwave ovens, stoves, or radiators. The device may explode if overheated. Follow all local regulations when disposing of a used device.
- Avoid exposing the device to high external pressure, which can lead to an internal short circuit and overheating.

Protect the device and charger from damage.

- Avoid exposing your device to excessive cold or heat. Extreme temperatures can damage the device and reduce the charging capacity and life of your device.
- Do not allow children or animals to bite or chew the device. Doing so can result in fire or explosion, and small parts can be a choking hazard. If children use the device, make sure they use the device properly.
- Never use a damaged charger.

Do not handle a damaged or leaking Lithium Polymer Battery battery. For safe disposal of your Lithium Polymer Battery battery, contact your nearest authorized service center.



Caution

Failure to comply with safety precautions and regulations can result in property damage, serious injury or death.

Do not use your device near other electronic devices. Most electronic devices use radio frequency signals. Your device may interfere with other nearby electronic devices.

Do not use your device near other devices that emit radio signals, such as sound systems or radio towers. Radio signals from these may cause your device to malfunction.

Do not expose the device to heavy smoke or fumes. Doing so may damage the outside of the device or cause it to malfunction.

If you notice strange smells or sounds coming from your device, or if you see smoke or liquid leaking from the device, stop using the device immediately and take it to a Pruveeo Service Center. Failure to do so may result in fire or explosion.

For your own safety, do not operate the controls of this product while driving. The window mount is needed when using the recorder in a car. Make sure that you place the recorder in a location where it will not obstruct the driver's view.

Always keep the camera lens clean, and ensure that the lens is not blocked by any object or placed near any reflective material. If the car's windshield is tinted with a dark coating, recording quality may be affected.

Do not store your device in excessively hot, cold, damp or dry locations. Doing so may cause the screen to malfunction, result in damage to the device, or cause the battery to explode.

Your device is recommended for use and store within a temperature range of 15 degrees Fahrenheit to 150 degrees Fahrenheit, and a humidity range of 10% to 80%.

If your device becomes overheated, allow it to cool down before use. Prolonged exposure of skin to an overheated device may cause low-temperature burn symptoms, such as red spots or areas of darker pigmentation.

Install mobile devices and equipment with caution.

- Ensure that any mobile devices or related equipment installed in your vehicle are securely mounted.
- Avoid placing your device and accessories in or near an airbag deployment area. Improperly installed wired equipment can cause serious injury in a situation where airbags inflate rapidly.

Do not drop your device or subject your device to impact. If the device is bent, deformed or damaged, malfunction may occur.

Take care to maximum battery and charger life:

- Your device may wear out over time. Some parts and repairs are covered by the warranty within the validity period, but damage or deterioration related to the use of unapproved accessories is not.

Do not attempt to disassemble, repair, or modify your device.

- Any changes or modifications to your device can void your manufacturer's warranty. If your device needs servicing, take it to an authorized Pruveeo Service Center.

Clean your device and charger by wiping with a towel or eraser. Do not use chemicals or detergents. Doing so can discolor or corrode the outside of the device, and may result in electric shock or fire.

Do not distribute copyright-protected material. Doing so without the permission of the content owners may violate copyright laws. The manufacturer is not responsible or liable for any legal issues that result from the user's illegal use of copyrighted material.

Correct disposal of this product

(applicable in countries with separate waste collection systems)



Waste Electrical & Electronic Equipment

This symbol, found on the device, accessories or accompanying literature, indicates that the product and its electronic accessories (e.g. charger, headset, USB cable) should not be disposed of with other household waste.

To prevent possible harm to the environment or human health from uncontrolled waste disposal, please separate these items from other types of waste and recycle them responsibly to promote the sustainable reuse of material resources.

Household users should contact either the retailer where they purchased this product, or their local government office, for information on where and how they can take these items for environmentally safe recycling.

Business users should contact their supplier and check the terms and conditions of the purchase contract. This product and its electronic accessories should not be mixed with other commercial wastes for disposal.

Disclaimer

Some content and services accessible through this device belong to third parties and are protected by copyright, patent, trademark and/or other intellectual property laws. Such content and services are provided solely for your personal non-commercial use.

You may not use any content or services in a manner that has not been authorized by the content owner or service provider. Without limiting the foregoing, unless expressly authorized by the applicable content owner or service provider, you may not modify, copy, republish, upload, post, transmit, translate, sell, create derivative works, exploit, or distribute in any manner or medium any content or services displayed through this device.

"THIRD PARTY CONTENT AND SERVICES ARE PROVIDED "AS IS." PRUVEEO DOES NOT WARRANT CONTENT OR SERVICES SO PROVIDED, EITHER EXPRESSLY OR IMPLIEDLY, FOR ANY PURPOSE. PRUVEEO EXPRESSLY DISCLAIMS ANY IMPLIED WARRANTIES, INCLUDING BUT NOT LIMITED TO, WARRANTIES OF MERCHANTABILITY OR FITNESS FOR A PARTICULAR PURPOSE. PRUVEEO DOES NOT GUARANTEE THE ACCURACY, VALIDITY, TIMELINESS, LEGALITY, OR COMPLETENESS OF ANY CONTENT OR SERVICE MADE AVAILABLE THROUGH THIS DEVICE AND UNDER NO CIRCUMSTANCES, INCLUDING NEGLIGENCE, SHALL PRUVEEO BE LIABLE, WHETHER IN CONTRACT OR TORT, FOR ANY DIRECT, INDIRECT, INCIDENTAL, SPECIAL OR CONSEQUENTIAL DAMAGES, ATTORNEY FEES, EXPENSES, OR ANY OTHER DAMAGES ARISING OUT OF, OR IN CONNECTION WITH, ANY INFORMATION CONTAINED IN, OR AS A RESULT OF THE USE OF ANY CONTENT OR SERVICE BY YOU OR ANY THIRD PARTY, EVEN IF ADVISED OF THE POSSIBILITY OF SUCH DAMAGES."

Third party services may be terminated or interrupted at any time, and Pruveeo makes no representation or warranty that any content or service will remain available for any period of time. Content and services are transmitted by third parties by means of networks and transmission facilities over which Pruveeo has no control. Without limiting the generality of this disclaimer, Pruveeo expressly disclaims any responsibility or liability for any interruption or suspension of any content or service made available through this device.

Pruveeo is neither responsible nor liable for customer service related to the content and services. Any question or request for service relating to the content or services should be made directly to the respective content and service providers.

Warm Prompt

We recommend that you carefully read this manual before using the dash cam, then read it again with the dash cam in your hands as this will help you to familiarize yourself with its many features. The dash cam is constantly improved over time, so the specification of the dash cam may change.

Please note that each button has multiple functions so please be careful which Buttons you press in relation to each Mode / Function. There is no need to get frustrated because you should only do this once in order to set it up in the way that you require.





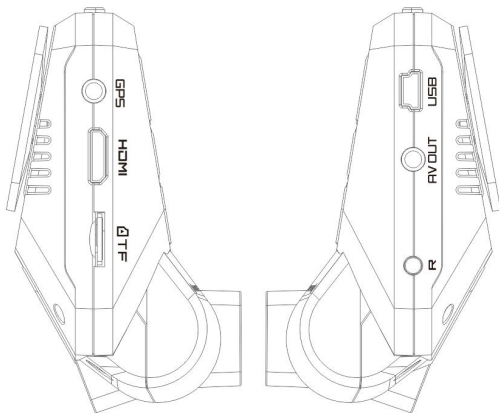
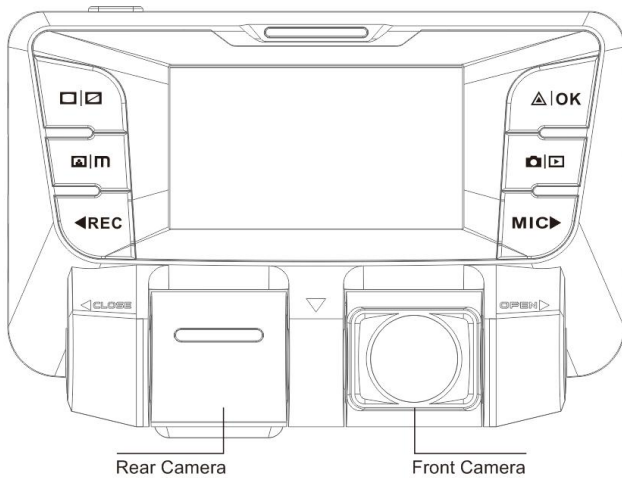

1. Please ensure that the dash cam is SWITCHED OFF when you either insert or remove a Micro SD Card, in order to avoid damage.
2. Please ensure that the Micro SD Card is inserted in the right way. If it is inserted backwards, it might damage the dash cam and Card.
3. If the Micro SD Card is not compatible with the dash cam, please DO NOT insert it again, as you will damage the Card and the dash cam. Please buy the correct Card and then try again.
4. The dash cam supports the Micro SD card from 8GB to the highest 32GB, Class 10 only.
5. Adjust the position of the lens to ensure that you correctly record what you want.
6. We recommend a 32 GB Class 10 Micro SD Card for this dash cam.
7. In video recording mode, if you want to press Menu / Mode button, please stop recording videos first by pressing the REC button.

8. When using the built-in power, the dash cam will prompt low power and save the document then turn off automatically if the power is not enough.
9. We recommend using default factory settings, once the MENU has been set, then connect the car charger to the unit and put into the card. Once the car is started, the unit will automatically start recording. Once the car turns off, the unit will automatically stop recording. Please note that your vehicle's Cigarette Lighter Sockets do not have any power when the ignition is switched OFF.
10. All dash cam models must be continuously connected to either a 12 or 24 Volt power supply via a 5V 1A Charger because a LCD colour screen consumes a considerable amount of power. That is why mobile phone / dash cam screens automatically go blank when not being used - to save power. A fully charged battery will only power the screen for a few minutes. It must always be connected to a power supply via a 5V 1A Charger.
11. If you turn the option of SCREEN SAVER ON, in video recording mode, when the screen is switched Off, the dash cam is still recording. You can turn the screen on by pressing power button.
12. If you want to playback the videos, we recommend unplugging your micro SD card and plugging into your PC with card reader. We recommend using VLC Video player on Windows OS, and Movist + VLC on MAC OS.
13. After several weeks of daily recording it may be necessary for you to format your Micro TF Memory Card - if that is the case, please note that you will lose all of your files, so please back up a copy on your computer first in a unique dash cam Folder that you have created.

14. When your dash cam crashes / screen goes black, the phenomenon may be caused by improper operation, crash, please press the R = Reset button, hole by the top corner, gently with a cocktail stick. Just like you would do for a computer, printer, phone, etc.
15. Dash cam only supports the micro SD card with the FAT file format, please format your micro SD card with the FAT32 file format on your PC first.
16. We recommend formatting your micro SD card once a month, and replace the micro SD card every three months because the memory card has a certain number of reads and writes, if it reaches the numbers, the micro SD card can't be used.

Device Layout



Button	Functions
	<ul style="list-style-type: none"> • Press to turn on and off screen • Hold to turn the device on or off
	<ul style="list-style-type: none"> • Press to confirm a selection while in Setting Mode • Recording Mode Hot Key: Emergency Lock (Press to manually lock the file during recording)
	<p>MENU – In standby mode, press ONE/TWICE to enter settings, press again to EXIT</p>
	<ul style="list-style-type: none"> • Press to navigate UP through options in Settings Mode • Recording Mode Hot Key: Record (Press to start / stop recording)
	<ul style="list-style-type: none"> • Press to navigate DOWN through options in Settings Mode • Recording Mode Hot Key: Mute (Press to mute / un-mute the microphone during recording)
	<p>MODE Select – Press to toggle between Recording / Photo / Playback modes</p>
	<p>SCREEN – Press to switch screen to Front, Rear, Picture in Picture</p>
<p>R</p>	<p>Press and hold for 4 seconds to reset the device in the event that it operates erratically, hangs up, or freezes</p>

Installation

1. Attaching the camera to the window mount

Before the device can be used in a car, it is essential to first install a properly attached window mount. Make sure that you place the recorder in a safe, appropriate location where it will not obstruct the driver's view.

2. Connecting the charger to the car's 12V DC outlet

Be sure to connect only the Pruveeo-approved charger designed and supplied specifically for use with your device. Using an incompatible charger can cause serious personal injury or damage to your device.

3. Inserting a memory card

You will need to insert a memory card before you can begin recording. The recorder supports Micro SD cards with a capacity of up to 32GB. For reliable operation, use a Class 10 memory card with a capacity of at least 8GB.

DO NOT insert or remove a memory card while the device is in operation.

Inserting the memory card

Your device accepts memory cards with a maximum capacity of 32GB. Depending on the memory card manufacturer and type, some cards may not be compatible with your device. Using an incompatible card may damage the device or the memory card, or corrupt the data stored on it.

Please let the screen of the C2 dash cam face you.

- Insert memory card with the gold-colored contacts facing you.
- Push the memory card into the slot until it locks in place.

It is recommended that you reformat a memory card after every time that images are transferred from it to a computer, or at least once a month.

Reformatting a memory card keeps important elements of data and file structure clean, helping to prevent error messages and missing images. Reformatting also restores the memory card, which can help prevent it from becoming corrupted.

Removing the memory card

Before removing a memory card from your computer, you must first unmount it for safe removal.

Before removing a memory card from your device:

1. Press the REC button to stop the device from recording
2. Press and hold  the ON/OFF button to switch off the device
3. Gently push the memory card in and let go until it unlocks

Do not remove the memory card while the device is transferring or accessing information. Doing so can result in data loss or corruption, or damage to the memory card or device. Pruveeo is not responsible for losses that result from the use of damaged memory cards, including the loss of data.

Formatting the memory card

You may choose to format your memory card with either the device or a computer. To use the device for formatting a memory card:

1. Press the REC button to stop the device from recording
2. Press the MENU button twice to enter System Settings
3. Press the DOWN button to navigate to the "Format" option
4. Press OK to confirm your selection
5. Press the UP button once
6. Press OK when the word YES is highlighted in blue

Before formatting a memory card, always remember to make backup copies of all important data stored on the device. The manufacturer's warranty does not cover loss of data resulting from user actions.

SYSTEM / VIDEO SETTINGS

Date/ Time Setup

Use the following procedure to change the device's time and date:

1. Press MENU twice to enter System Settings
2. Press the DOWN button to navigate to the "Date/Time" option
3. Press OK to view date/time in the format: YYYY/MM/DD HH:MM:SS
4. Press the UP or DOWN button to change the highlighted number
5. Press OK to move to the next date/time segment and repeat step 4
6. Press OK again to confirm your entry
7. Press MENU to exit System Settings

Note: If the battery remains fully discharged or is removed from the device, the time and date will be reset.

Language

Use the following procedure to change the device's time and date. Language availability may vary depending on the region.

1. Press MENU twice to enter System Settings
2. Press the DOWN button to navigate to the "Language" option
3. Press OK to view the current language selection
4. Press the UP or DOWN button to change the selection
5. Press OK again to confirm your choice

Resolution

Use the following procedure to set the recording resolution:

1. Press MENU once to enter Video Settings
2. Press the UP or DOWN button to navigate to the "Resolution" option
3. Press OK to view available resolutions:
 - FHD P30 + FHD P30 (1080P+1080P, 30fps, dual channel)
 - HD P30 + HD P30 (720P+720P, 30fps, dual channel)
 - UHD P24 (2196P, 24fps, single channel)
 - QHD P30 (1440P, 30fps, single channel)
 - FHD P60 (1080P, 60fps, single channel)
 - FHD P30 (1080P, 30fps, single channel)
 - HD P120 (720P, 120fps, single channel)
 - HD P60 (720P, 60fps, single channel)
 - HD P30 (720P, 30fps, single channel)
4. Press the UP or DOWN button to make your selection
5. Press OK to confirm your entry
6. Press MENU to exit Video Settings

Date and Time Stamp

You have the option to display the date and time in your videos. Note that the date and time stamp cannot be removed from videos if this feature was enabled at the time of recording.

1. Press MENU once to enter Video Settings
2. Press the UP or DOWN button to navigate to the "Date Stamp" option
3. Press OK to view the current ON/OFF status for this feature
4. Press the UP or DOWN button to enable or disable this feature
5. Press OK to confirm your entry
6. Press MENU to exit Video Settings

Loop Recording

With Loop Recording Mode enabled, the device will continuously erase older video as it records new video, keeping only the images captured over a user-selected time range. All video older than this range will be replaced with new video. (Note: any locked video files on the memory card will remain protected, and will not be automatically deleted during Loop Recording.)

It is recommended that you reformat a memory card after every time that images are transferred from it to a computer, or at least once a month. This keeps important elements of data and file structure clean, helping to prevent error messages and missing images.

Remember to always make backup copies of all important data stored on the device. The manufacturer's warranty does not cover loss of data resulting from user actions.

1. Press MENU once to enter Video Settings
2. Press the UP or DOWN button to navigate to the "Loop Recording" option
3. Press OK to view the current selection: 1min / 3min / OFF
4. Press the UP or DOWN button to make your selection
5. Press OK to confirm your entry
6. Press MENU to exit Video Settings

Recording Audio

You may choose to record audio with video, or turn off the microphone so that all recorded videos will be muted.

1. Press MENU once to enter Video Settings
2. Press the UP or DOWN button to navigate to the "Record Audio" option
3. Press OK to view the current ON/OFF status for this feature
4. Press the UP or DOWN button to enable or disable this feature
5. Press OK to confirm your entry
6. Press MENU to exit Video Settings

Alternatively, you can use a hot key shortcut for this feature. During Recording Mode, press the DOWN button to mute / unmute the microphone for video recording.

LCD Display (Screen Saver)

Select a time duration for the screen to stay lit after recording starts.

1. Press MENU twice to enter System Settings
2. Press the UP or DOWN button to navigate to the "Screen Saver" option
3. Press OK to view the current selection: 1min / 3min / OFF
4. Press the UP or DOWN button to make your selection
5. Press OK to confirm your entry
6. Press MENU to exit System Settings

Alternatively, you can use a hot key shortcut for this feature. During Recording Mode, press and hold OK to turn the LCD screen on or off.

Auto Power Off

When enabled, this option allows the device to shut down automatically if Recording Mode is not engaged.

1. Press MENU twice to enter System Settings
2. Press the UP or DOWN button to navigate to the "Auto Power Off" option
3. Press OK to view the current selection: 3min/5min/10min/OFF
4. Press the UP or DOWN button to make your selection
5. Press OK to confirm your entry
6. Press MENU to exit System Settings

WDR (Wide Dynamic Range)

When enabled, this feature automatically adjusts exposure settings to improve recording quality in particularly bright or dim environments, providing balanced lighting and clearer recorded video.

1. Press MENU once to enter Video Settings
2. Press the UP or DOWN button to navigate to the "WDR" option
3. Press OK to view the current ON/OFF status for this feature
4. Press the UP or DOWN button to enable or disable this feature
5. Press OK to confirm your entry
6. Press MENU to exit Video Settings

Beep Sound

This setting allows you to turn the device's button sound effect on or off.

1. Press MENU twice to enter System Settings
2. Press the UP or DOWN button to navigate to the "Beep Sound" option
3. Press OK to view the current ON/OFF status for this feature
4. Press the UP or DOWN button to enable or disable this feature
5. Press OK to confirm your entry
6. Press MENU to exit System Settings

Light Frequency

This option should be set according to the power supply specification used in your country or geographical region (U.S. users should select the "60Hz" option).

1. Press MENU twice to enter System Settings
2. Press the UP or DOWN button to navigate to the " Frequency" option
3. Press OK to view the current selection: 50Hz / 60Hz
4. Press the UP or DOWN button to make your selection
5. Press OK to confirm your entry
6. Press MENU to exit System Settings

Exposure

Adjust the camera exposure value for brighter or darker recorded video, according to your preference.

1. Press MENU once to enter Video Settings
2. Press the UP or DOWN button to navigate to the "Exposure" option
3. Press OK to view the current selection: +0.0, +1/3, -1/3, etc.
4. Press the UP or DOWN button to make your selection
5. Press OK to confirm your entry
6. Press MENU to exit Video Settings

Plate Number

Enable this feature to enter a vehicle plate number for video recording.

1. Press MENU once to enter Plate Number Settings
2. Press the UP or DOWN button to navigate to the "Plate Number" option
3. Press the UP or DOWN button to change the value
4. Press the UP (REC) button and MENU to disable current segment
5. Press MENU to move to next segment
6. Press OK to confirm your entry
7. Press MENU to exit Plate Number Settings

Restore Default Factory Settings

Performing this operation will reset all of your device's settings to their original values. Note: any user-customized settings will be lost.

1. Press MENU twice to enter System Settings
2. Press the UP or DOWN button to navigate to the "Default Settings" option
3. Press OK to view YES / NO confirmation for this operation
4. Press the UP or DOWN button to make your selection
5. Press OK to confirm your entry
6. Press MENU to exit System Settings

Playback Mode

You can play back recorded video on your device using the following steps:

1. Press REC to stop recording
2. Press MODE twice to switch from Recording to Playback Mode
3. Press and hold the UP or DOWN button to navigate through the stored video files
4. Press OK to start playback for the selected video
5. Press OK again to pause playback
6. Press MODE to stop playback
7. FAST FORWARD: While video is playing, press the UP button one or more times to set fast playback speed (2X / 4X / 8X)
8. FAST REWIND: While video is playing, press the DOWN button one or more times to set reverse playback speed (-2X / -4X / -8X)

Deleting Files

To delete one particular file:

1. Press the UP or DOWN button to navigate through the stored video files
2. Press MENU to view options for the highlighted file:
Delete/Protect/Slide Show
3. Press the DOWN button once to select "Delete"
4. Press OK once to view options for "Current MOV" file or "ALL" files.
Select "Current MOV"
5. Press OK twice to delete file

Contact US

Website: www.pruveeo.us

Email: support@pruveeo.us

Office Address: 5688 Whitehorn Way, Blaine, WA 98230

If you have any question, please contact us with no hesitation at support@pruveeo.us for quick solutions. Every customer contact will be issued within 24 hours.